

# *i 24, i 30, i 35*

combination boilers

## **USER GUIDE**

**For Installation Guide see reverse of book**

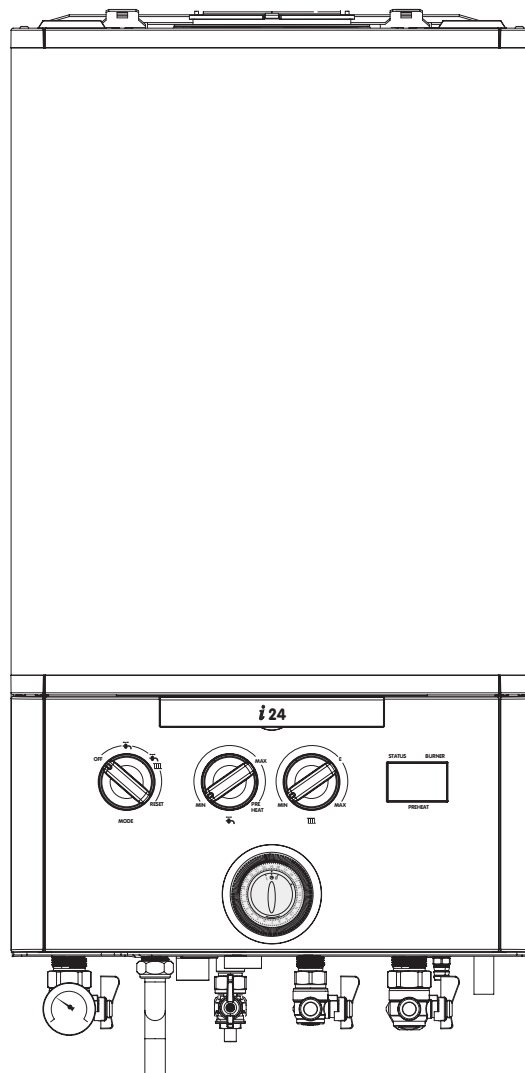

UIN 212132 A07  
June 2018

THESE INSTRUCTIONS TO BE RETAINED BY USER

# CONTENTS

<b>1. Introduction</b> .....	<b>2</b>
Safety .....	2
Electricity Supply .....	2
Important Notes .....	2
<b>2. Boiler Operation</b> .....	<b>3</b>
Controls Diagram.....	3
To Start the Boiler.....	3
Operation Modes.....	3
Preheat Domestic Hot Water.....	3
Control of Water Temperature .....	3
Efficient Heating System Operation.....	4
Weather Compensation.....	4
Boiler Frost Protection.....	4
Boiler Reset.....	4
Mains Power Off.....	4
<b>3. System Water Pressure</b> .....	<b>4</b>
<b>4. Condensate Drain</b> .....	<b>4</b>
<b>5. General Information</b> .....	<b>5</b>
Boiler Pump.....	5
Minimum Clearances.....	5
Escape of Gas.....	5
Cleaning .....	5
Maintenance .....	5
<b>6. Mechanical 24 Hour Timer</b> .....	<b>5</b>
<b>7. Points for the Boiler User</b> .....	<b>6</b>
Troubleshooting .....	6
<b>8. Normal Operation Display Codes</b> .....	<b>7</b>
<b>9. Fault Codes</b> .....	<b>8</b>

## 1. INTRODUCTION

The *i combi* is a combination boiler providing both central heating and instantaneous domestic hot water. Featuring full sequence automatic ignition and fan assisted combustion.

Due to the high efficiency of the boiler, condensate is produced from the flue gases and this is drained to a suitable disposal point through a plastic waste pipe at the base of the boiler. A condensate 'plume' will also be visible at the flue terminal.

### SAFETY

#### Current Gas Safety (Installation & Use) Regulations or rules in force.

In your own interest, and that of safety, it is the law that this boiler must be installed by a Gas Safe Registered Engineer, in accordance with the above regulations.

In IE, the installation must be carried out by a Registered Gas Installer (RGI) and installed in accordance with the current edition of I.S. 813 "Domestic Gas Installations", the current Building Regulations and reference should be made to the current ETCI rules for electrical installation.

*It is essential that the instructions in this booklet are strictly followed, for safe and economical operation of the boiler.*

### ELECTRICITY SUPPLY

**This appliance must be earthed.**

**Supply: 230 V ~ 50 Hz. The fusing should be 3A.**

### IMPORTANT NOTES

- This appliance must not be operated without the casing correctly fitted and forming an adequate seal.
- If the boiler is installed in a compartment then the compartment **MUST NOT** be used for storage purposes.
- If it is known or suspected that a fault exists on the boiler then it **MUST NOT BE USED** until the fault has been corrected by a Gas Safe Registered Engineer or in IE a Registered Gas Installer (RGI).
- Under **NO** circumstances should any of the sealed components on this appliance be used incorrectly or tampered with.
- This appliance can be used by children 8 years and above. Also persons with reduced physical, sensory or mental capabilities, or lack of experience and knowledge, provided they have been given supervision or instruction concerning use of the appliance in a safe way and understand the hazards involved. Children shall not play with the appliance. Cleaning and user maintenance shall not be made by children without supervision.

All Gas Safe Register installers carry a Gas Safe Register ID card, and have a registration number. Both should be recorded in the Benchmark Commissioning Checklist. You can check your installer by calling Gas Safe Register direct on 0800 4085500.

**Ideal** is a member of the Benchmark scheme and fully supports the aims of the programme. Benchmark has been introduced to improve the standards of installation and commissioning of central heating systems in the UK and to encourage the regular servicing of all central heating systems to ensure safety and efficiency.

**THE BENCHMARK SERVICE INTERVAL RECORD MUST BE COMPLETED AFTER EACH SERVICE**



## 2. BOILER OPERATION

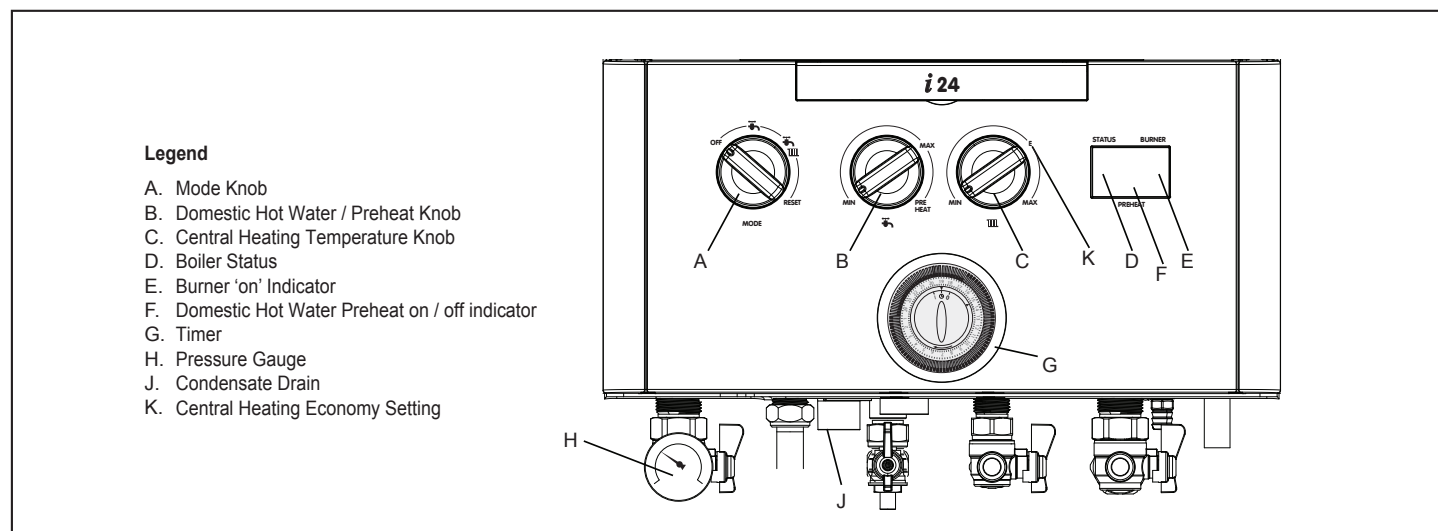

### TO START THE BOILER

Start the boiler as follows:

1. Check that the electricity supply to boiler is off.
2. Set the mode knob (A) to 'OFF'.
3. Set the Domestic Hot Water temperature knob (B) and Central Heating temperature knob (C) to 'MAX'.
4. Ensure that all hot water taps are turned off.
5. Switch on electricity to the boiler and check that all external controls, e.g. timer and room thermostat, are on.
7. Set the mode knob (A) to '❄️' (winter).

The boiler will commence ignition sequence, supplying heat to the central heating, if required.

**Note.** In normal operation the boiler status display (D) will show codes:

- D* Standby - no demand for heat.
- C* Central Heating being supplied
- d* Domestic hot water being supplied
- P* Domestic hot water preheat
- F* Boiler frost protection - boiler will fire if temperature is below 5°C.

During normal operation the burner on indicator (E) will remain illuminated when the burner is lit.

Note: If the boiler fails to light after five attempts the fault code L-2 will be displayed (refer to Fault Code page).

### OPERATION MODES

**Winter Conditions** - (Central Heating and Domestic Hot Water required)

Set the mode knob (A) to '❄️' (winter).

The boiler will fire and supply heat to the radiators but will give priority to domestic hot water on demand.

The domestic hot water preheat will operate if preheat is enabled (shown by indicator light (F)).

**Summer Conditions** - (Domestic Hot Water only required)

Set the mode knob (A) to '☀️' (summer).

Set the central heating demand on the external controls to OFF.

The domestic hot water preheat will operate if preheat is enabled (shown by indicator light (F)).

### Boiler Off

Set the mode knob (A) to 'OFF'. The boiler mains power supply must be left on to enable frost protection (see Frost Protection).

### PREHEAT - DOMESTIC HOT WATER

The domestic hot water heat exchanger within the boiler can be kept preheated to provide faster delivery of hot water at the tap.

Preheat is enabled when the preheat indicator (F) is lit. To switch preheat on or off, move the domestic hot water preheat knob (B) full clockwise and then return it to the required domestic hot water temperature setting.

The boiler will operate periodically for a few seconds to maintain the domestic hot water heat exchanger in a preheated condition. The average time period between operation is 90 minutes. This may vary considerably due to the surrounding ambient temperature of the boiler. The boiler will operate whenever there is a demand for domestic hot water.

If standard hot water delivery is satisfactory turn the knob (A) to 'OFF'.

### CONTROL OF WATER TEMPERATURE

#### Domestic Hot Water

The domestic hot water temperature is limited by the boiler controls to a maximum temperature of 64°C, adjustable via the domestic hot water temperature knob (B).

Approximate temperatures for domestic hot water:

Knob Setting	Hot Water Temperature (approx.)
Minimum	40°C (104°F)
Maximum	64°C (147°F)

Due to system variations and seasonal temperature fluctuations domestic hot water flow rates/temperature rise will vary, requiring adjustment at the tap: the lower the flow rate the higher the temperature, and vice versa.

#### Central Heating

The boiler controls the central heating radiator temperature to a maximum of 80°C, adjustable via the central heating temperature knob (C).

Approximate temperatures for central heating:

Knob Setting	Central Heating Radiator Temperature (approx.)
Minimum	45°C (113°F)
Maximum	80°C (176°F)

For economy setting 'E' refer to Efficient Heating System Operation.

## EFFICIENT HEATING SYSTEM OPERATION

The boiler is a high efficiency, condensing appliance which will automatically adjust its output to match the demand for heat. Therefore gas consumption is reduced as the heat demand is reduced.

The boiler condenses water from the flue gases when operating most efficiently. To operate your boiler efficiently (using less gas) turn the central heating temperature knob (C) to the 'E' position or lower. In winter periods it may be necessary to turn the knob towards the 'MAX' position to meet heating requirements. This will depend on the house and radiators used.

Reducing the room thermostat setting by 1°C can reduce gas consumption by up to 10%.

## WEATHER COMPENSATION

When the Weather Compensation option is fitted to the system then the central heating temperature knob (C) becomes a method of controlling room temperature. Turn the knob clockwise to increase room temperature and anti-clockwise to decrease room temperature. Once the desired setting has been achieved, leave the knob in this position and the system will automatically achieve the desired room temperature for all outside weather conditions.

## BOILER FROST PROTECTION

The boiler is fitted with frost protection that operates in all modes, provided the power supply to the boiler is always turned on. If the water in the boiler falls below 5°C, the frost protection will activate and run the boiler to avoid freezing. The process does not guarantee that all other parts of the system will be protected.

If a system frost thermostat has been installed, the boiler must be set in winter mode, '❄️', for the system frost protection to run.

If no system frost protection is provided and frost is likely during a short absence from home it is recommended to leave the system heating controls or built in programmer (if fitted) switched on and run at a reduced temperature setting. For longer periods, the entire system should be drained.

## BOILER RESET

To reset the boiler, when directed in the listed fault codes (see section 9), turn the mode knob (A) to 'reset' position and IMMEDIATELY turn knob back to required setting. The boiler will repeat its ignition sequence. If the boiler still fails to start consult a Gas Safe Registered Engineer or in IE a Registered Gas Installer (RGII).

## MAINS POWER OFF

To remove all power to the boiler the mains power switch must be turned off.

## 3. SYSTEM WATER PRESSURE

The system pressure gauge (H - see page 3) indicates the central heating system pressure. If the pressure is seen to fall below the original installation pressure of 1-2 bar over a period of time and continue to fall then a water leak may be indicated. In this event re-pressurise the system. If unable to do so or if the pressure continues to drop a Gas Safe Registered Engineer or in IE a Registered Gas Installer (RGII) should be consulted.

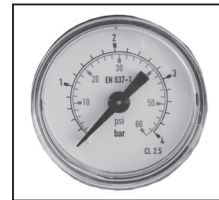

**THE BOILER WILL NOT OPERATE IF THE PRESSURE HAS REDUCED TO LESS THAN 0.3 BAR UNDER THIS CONDITION.**

## 4. CONDENSATE DRAIN

This appliance is fitted with a siphonic condensate trap system that reduces the risk of the appliance condensate from freezing. However should the condensate pipe to this appliance freeze, please follow these instructions:

- If you do not feel competent to carry out the defrosting instructions below please call your local Gas Safe Registered installer for assistance.
- If you do feel competent to carry out the following instructions please do so with care when handling hot utensils. Do not attempt to thaw pipework above ground level.

If this appliance develops a blockage in its condensate pipe, its condensate will build up to a point where it will make a gurgling noise prior to locking out an "L2" fault code. If the appliance is restarted it will make a gurgling noise prior to locking out on a failed ignition "L2" code.

To unblock a frozen condensate pipe;

- Follow the routing of the plastic pipe from its exit point on the appliance, through its route to its termination point. Locate the frozen blockage. It is likely that the pipe is frozen at the most exposed point external to the building or where there is some obstruction to flow. This could be at the open end of the pipe, at a bend or elbow, or where there is a dip in the pipe in which condensate can collect. The location of the blockage should be identified as closely as possible before taking further action.
- Apply a hot water bottle, microwaveable heat pack or a warm damp cloth to the frozen blockage area. Several applications may have to be made before it fully defrosts. Warm water can also be poured onto the pipe from a watering can or similar. DO NOT use boiling water.
- Caution when using warm water as this may freeze and cause other localised hazards.
- Once the blockage is removed and the condensate can flow freely, reset the appliance. (Refer to "To Light the boiler")
- If the appliance fails to ignite, call your Gas Safe Registered engineer.

### Preventative solutions

During cold weather, set the central heating temperature knob (C) to maximum, (Must return to original setting once cold spell is over).

Place the heating on continuous and turn the room thermostat down to 15°C overnight or when unoccupied. (Return to normal after cold spell).

## 5. GENERAL INFORMATION

### BOILER PUMP

The boiler pump will operate briefly as a self-check once every 24 hours, regardless of system demand.

### MINIMUM CLEARANCES

Clearance of 165mm (6 1/2") above, 100mm (4") below, 2.5mm (9/8") at the sides and 450mm (17 3/4") at the front of the boiler casing must be allowed for servicing.

### Bottom Clearance

Bottom clearance after installation can be reduced to 5mm

This must be obtained with an easily removable panel, to enable the system pressure gauge to be visible and to provide the 100mm clearance required for servicing.

### ESCAPE OF GAS

Should a gas leak or fault be suspected contact the National Gas Emergency Service without delay. **Telephone 0800 111 999.**

### Ensure that;

- All naked flames are extinguished
- Do not operate electrical switches
- Open all windows and doors

### CLEANING

For normal cleaning simply dust with a dry cloth. To remove stubborn marks and stains, wipe with a damp cloth and finish off with a dry cloth. **DO NOT use abrasive cleaning materials.**

### MAINTENANCE

The appliance should be serviced at least once a year by a Gas Safe Registered Engineer or in IE a Registered Gas Installer (RGI).

## 6. MECHANICAL 24 HOUR TIMER

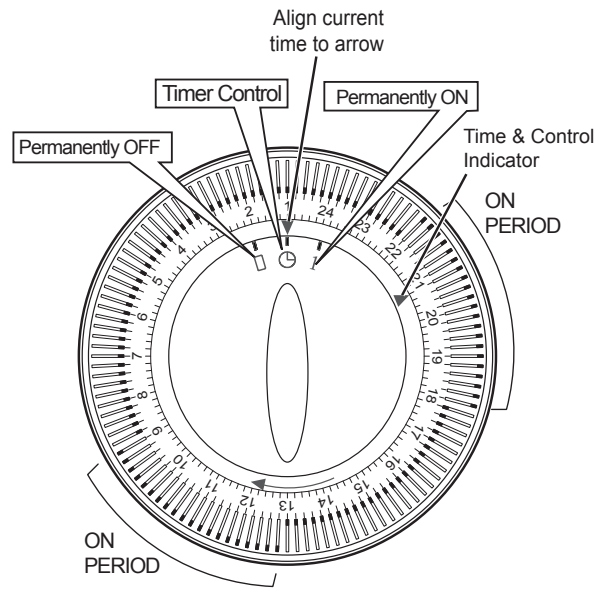

### SETTING UP

The outer dial should be set to the current time. Rotate the dial slowly in a clockwise direction, until the correct hour is aligned with the arrow printed on the dial.

Note that the outer dial is printed with the 24hr clock e.g. 8.00am = 8 on the dial, 8.00pm = 20 on the dial.

**Do not attempt to rotate the dial in an anti-clockwise direction.**

### PROGRAMMING SWITCHING TIMES

Set tappets to outer edge for ON periods and set tappets to inner edge for OFF periods.

The example shown has been set with 2 on periods.

ON at 9.00am. OFF at 1.00pm. (13 hours)

ON at 6.00pm. (18 hours) OFF at 10.00pm (22 hours)

### Manual Switch Operation

To set the timer for timed operation move the switch to the "TIMED" position.

To set the timer to be continuously on, move the switch to the "MANUAL ON" position.

To set the timer to be continuously off, move the switch to the "MANUAL OFF" position.

**Note.** If boiler does not light when in "timed on" or "manual on" position, increase temperature on room stat.





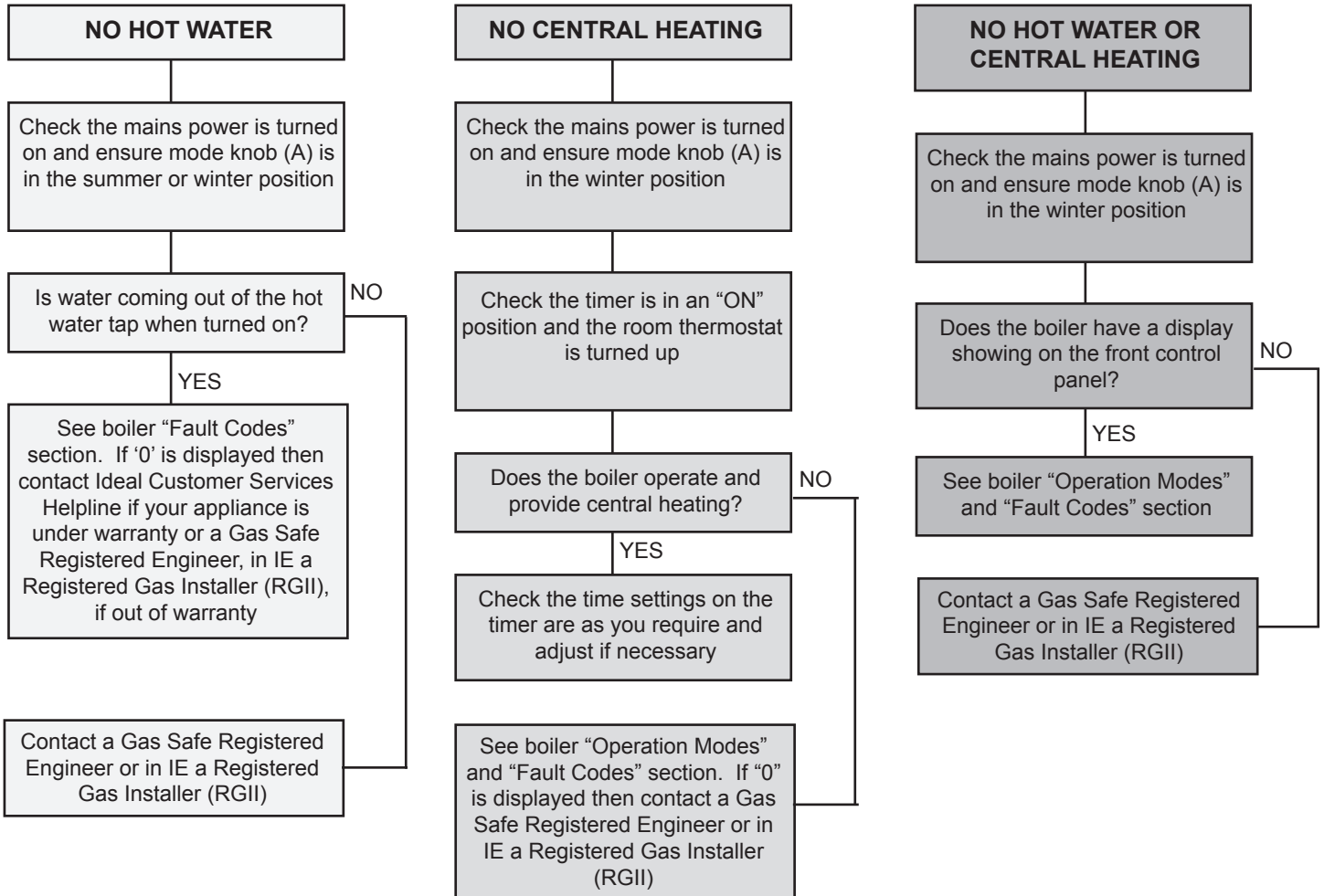

## 7. POINTS FOR THE BOILER USER

**Note.** In line with our current warranty policy we would ask that you check through the following guide to identify any problems external to the boiler prior to requesting a service engineers visit. Should the problem be found to be other than with the appliance we reserve the right to levy a charge for the visit, or for any pre-arranged visit where access is not gained by the engineer.

### TROUBLESHOOTING



## 8. NORMAL OPERATION DISPLAY CODES

DISPLAY CODE ON BOILER	DESCRIPTION
	The boiler is in standby mode awaiting either a central heating call or hot water demand.
	The boiler has a call for central heating but the appliance has reached the desired temperature set on the boiler.
	The boiler has a call for hot water but the appliance has reached the desired temperature set on the boiler.
	The boiler is operating in central heating mode.
	The boiler is operating in hot water mode.
	The boiler is operating in pre heat mode.
	The boiler is operating in frost mode.

*continued . . . . .*

**FOR ANY QUERIES PLEASE RING THE  
i COMBI CONSUMER HELPLINE : 01482 498660**











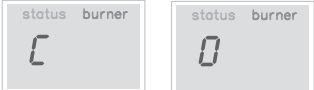

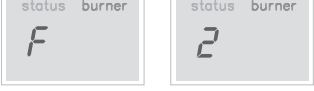
**NOTE. BOILER RESET PROCEDURE -**

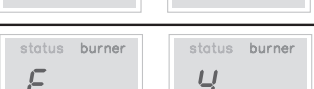
**To reset boiler, turn mode control knob to reset position and immediately turn knob back to required setting.**

*continued . . . . .*

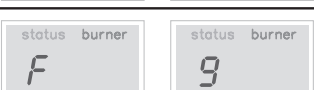

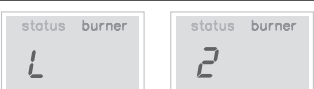
## 9. FAULT CODES

DISPLAY CODE ON BOILER	DESCRIPTION	ACTION
	BCC Activation Fault	Reset the appliance - if the boiler fails to operate then please contact Ideal Boilers (if under warranty) or alternatively a Gas Safe Registered Engineer if outside of the warranty period. In IE contact a Registered Gas Installer (RGII).
	BCC Fault	
	Low Water Pressure	Check system water pressure is between 1 & 1.5bar on the system pressure gauge (G). To re-pressurise the system see Section 3. If the boiler still fails to operate then please contact Ideal Boilers (if under warranty) or alternatively a Gas Safe Registered Engineer if outside of the warranty period. In IE contact a Registered Gas Installer (RGII).
	Flame Loss	<ol style="list-style-type: none"> <li>1. Check other gas appliances in the house are working to confirm a supply is present in the property.</li> <li>2. If other appliances do not work or there are no other appliances, check the gas supply is on at the meter and/or pre payment meter has credit. If the boiler fails to operate then please contact Ideal Boilers (if under warranty) or alternatively a Gas Safe Registered Engineer if outside of the warranty period. In IE contact a Registered Gas Installer (RGII).</li> </ol>
	Fan Fault	Reset the appliance - if the boiler fails to operate then please contact Ideal Boilers (if under warranty) or alternatively a Gas Safe Registered Engineer if outside of the warranty period. In IE contact a Registered Gas Installer (RGII).
	Flow Thermistor	Reset the appliance - if the boiler fails to operate then please contact Ideal Boilers (if under warranty) or alternatively a Gas Safe Registered Engineer if outside of the warranty period. In IE contact a Registered Gas Installer (RGII).
	Return Thermistor	Reset the appliance - if the boiler fails to operate then please contact Ideal Boilers (if under warranty) or alternatively a Gas Safe Registered Engineer if outside of the warranty period. In IE contact a Registered Gas Installer (RGII).
	Outside Sensor Failure	Reset the appliance - if the boiler fails to operate then please contact Ideal Boilers (if under warranty) or alternatively a Gas Safe Registered Engineer if outside of the warranty period. In IE contact a Registered Gas Installer (RGII).
	Low Mains Voltage	Contact a qualified electrician or your electricity provider.
	Unconfigured PCB	Unconfigured PCB. Please contact Ideal Boilers (if under warranty) or alternatively a Gas Safe Registered Engineer if outside of the warranty period. In IE contact a Registered Gas Installer (RGII).
	Flow Temperature Overheat or No Water Flow	Check system water pressure is between 1 & 1.5bar on the system pressure gauge (G). To re-pressurise the system see Section 3. If the boiler fails to operate then please contact Ideal Boilers (if under warranty) or alternatively a Gas Safe Registered Engineer if outside of the warranty period. In IE contact a Registered Gas Installer (RGII).
	Flame Loss	<ol style="list-style-type: none"> <li>1. Check other gas appliances in the house are working to confirm a supply is present in the property.</li> <li>2. If other appliances do not work or there are no other appliances, check the gas supply is on at the meter and/or pre payment meter has credit. If the boiler fails to operate then please contact Ideal Boilers (if under warranty) or alternatively a Gas Safe Registered Engineer if outside of the warranty period. In IE contact a Registered Gas Installer (RGII).</li> </ol>
	5 Boiler Resets in 15 minutes	<ol style="list-style-type: none"> <li>1. Turn electrical supply to boiler off and on.</li> <li>2. If the boiler fails to operate please contact Ideal Boilers (if under warranty) or alternatively a Gas Safe Registered Engineer if outside of the warranty period. In IE contact a Registered Gas Installer (RGII).</li> </ol>
	False Flame Lockout	Reset the appliance - if the boiler fails to operate then please contact Ideal Boilers (if under warranty) or alternatively a Gas Safe Registered Engineer if outside of the warranty period. In IE contact a Registered Gas Installer (RGII).